

SECM for bio-sensors

Nicolas Murer, Ph.D.
Product Manager

- Understand the principles of dc-SECM
- Be aware of all the operating modes of SECM
 - Feedback (FB)
 - Positive (+FB)
 - Negative (-FB)
 - Generation/Collection (G/C)
 - Sample Generation/Tip Collection (SG/TC)
 - Tip Generation/Sample Collection (TG/SC)
 - Direct Mode (DM)
- Understand the principles of bio-sensors

Fields of interest

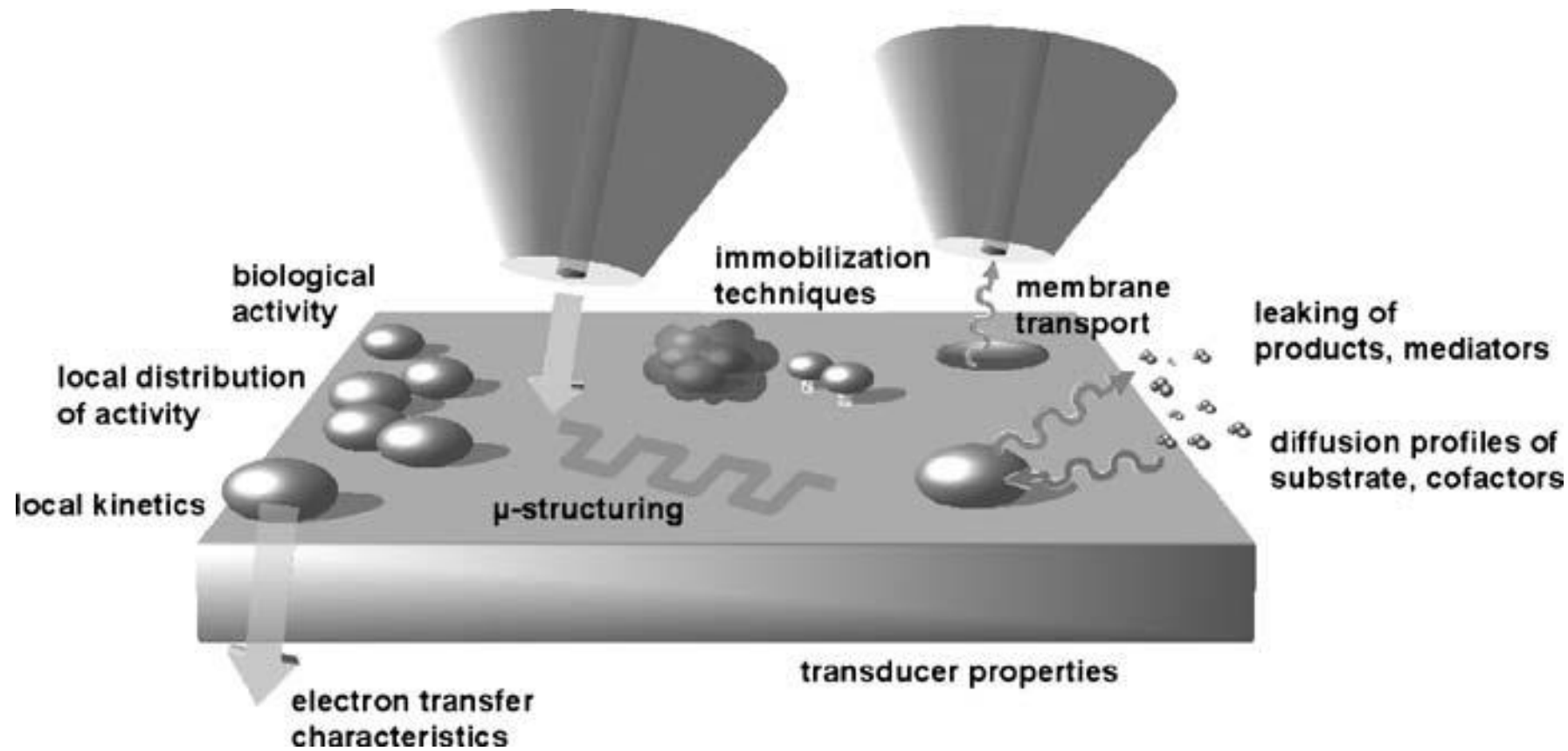

Fields of interest in biosensor research that can be addressed by SECM.
Measurements are performed in electrolyte solution.

General advantages

- Provide spatially-resolved information on the local electrochemical activity at the surface
- Measurement performed in electrolyte solution = objects are not denatured
- No need to label the biomolecules with fluorescent dyes to allow detection, the detection comes for electron flow.
- Specific molecules can be produced at the tip, and the reactivity of the receptors towards these molecules can be specifically tested.

G/C mode for O₂ reduction activity

H₂O₂ detection using a micro biosensor: horseradish peroxidase (HRP) « wired » to an 8 μm diameter C electrode using an osmium redox polymer

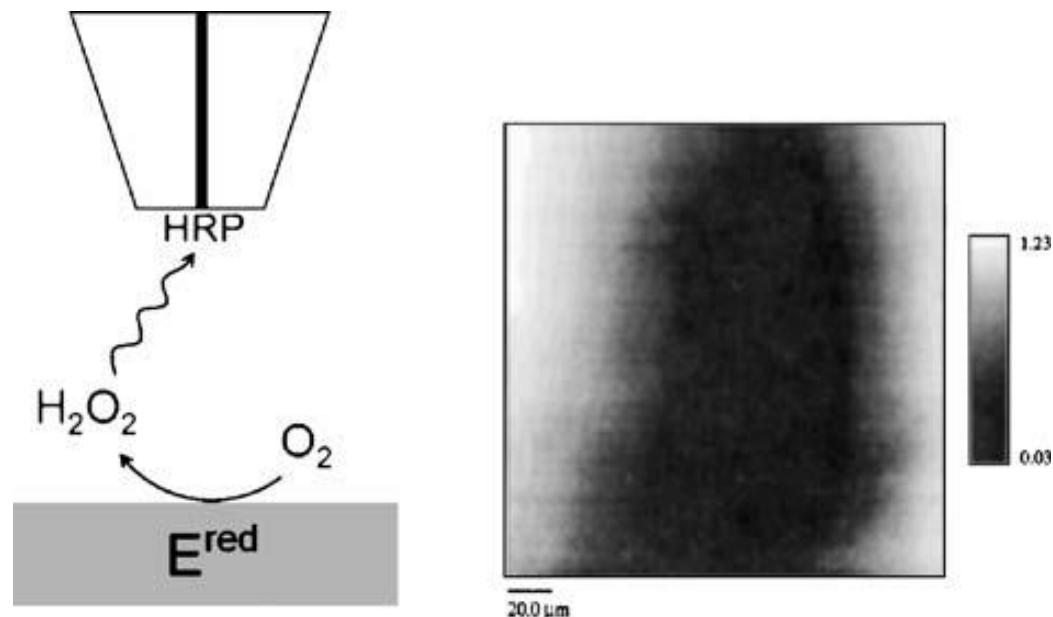

Application of a HRP-modified microbiosensor as SECM tip in the generation/collection mode.
 Right: SECM image of the H₂O₂ concentration profile at an unbiased 25 μm Pt disk electrode acquired with a HRP-modified carbon fiber electrode.

G/C mode for immobilization studies

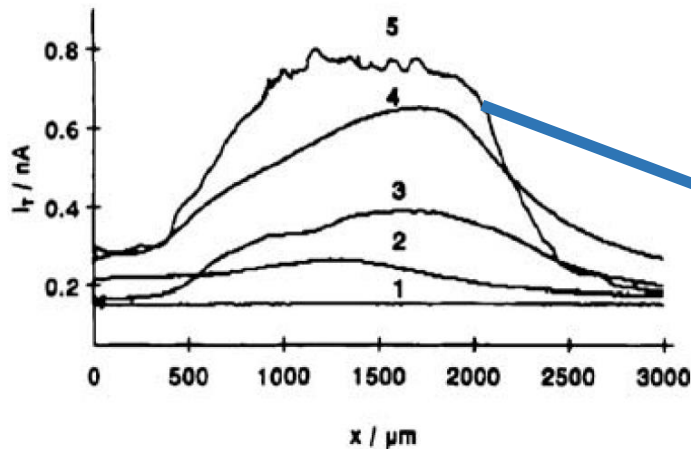
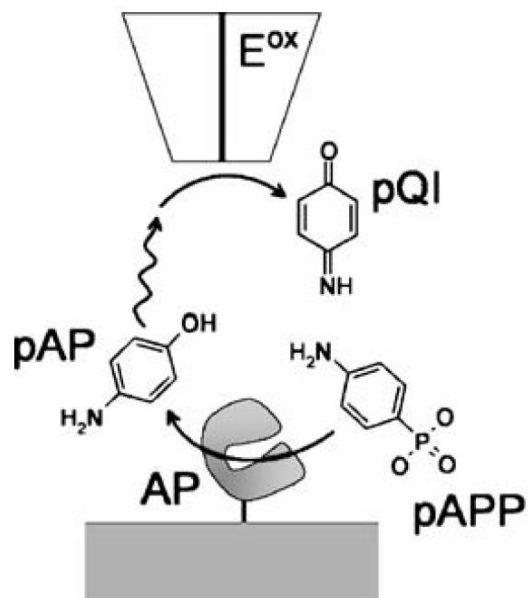

Horizontal line scans across spots with covalently attached monoclonal anti-digoxin Ab (antibody) after reaction with enzyme-labeled digoxin.

Dilutions of the incubated Ab solutions: (1) no Ab solution applied, (2) 1:3, (3) 1:4, (4) 1:2, and (5) undiluted antibody stock solution, $0.141 \text{ mg}\cdot\text{mL}^{-1}$ protein.

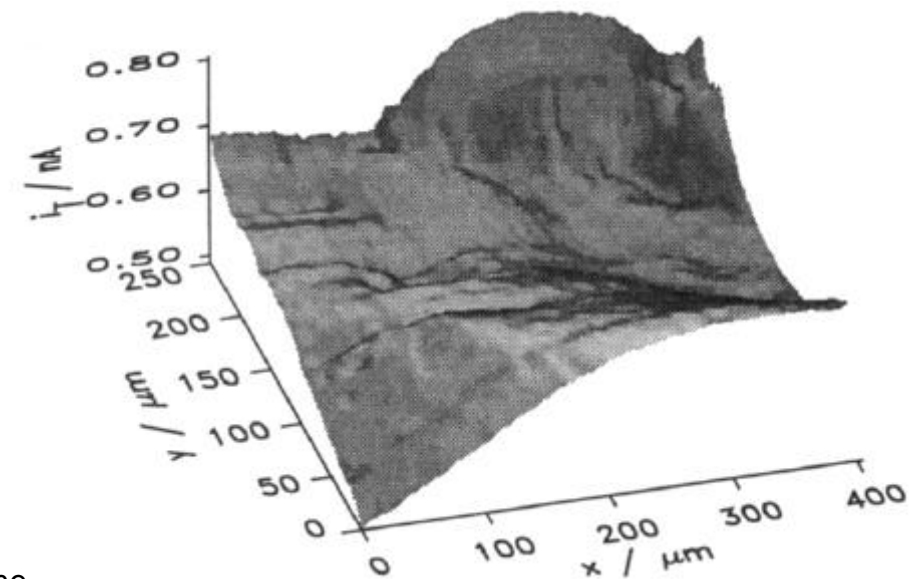

Increasing the antibody concentration increases the immobilization rate.
Spatial heterogeneity of the immobilization of the enzyme can be studied.

G/C mode for immobilization studies

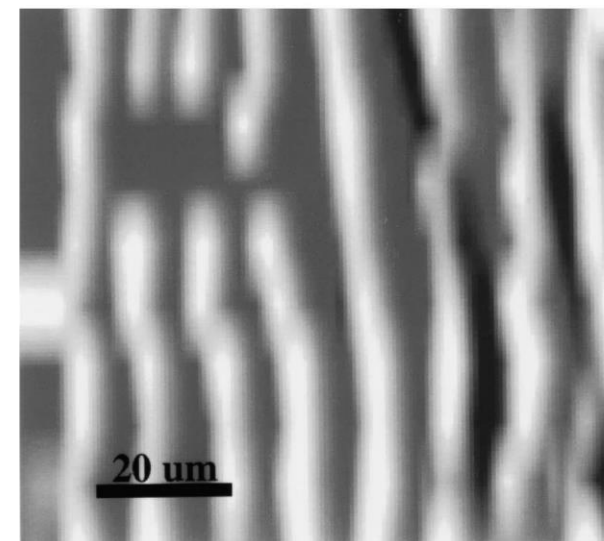
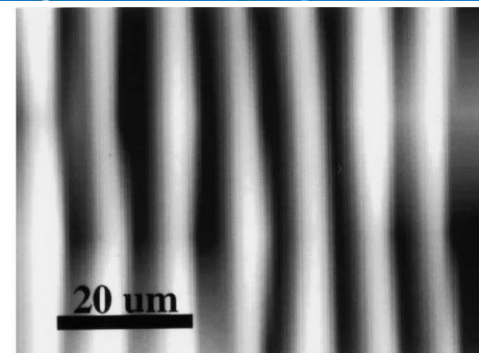
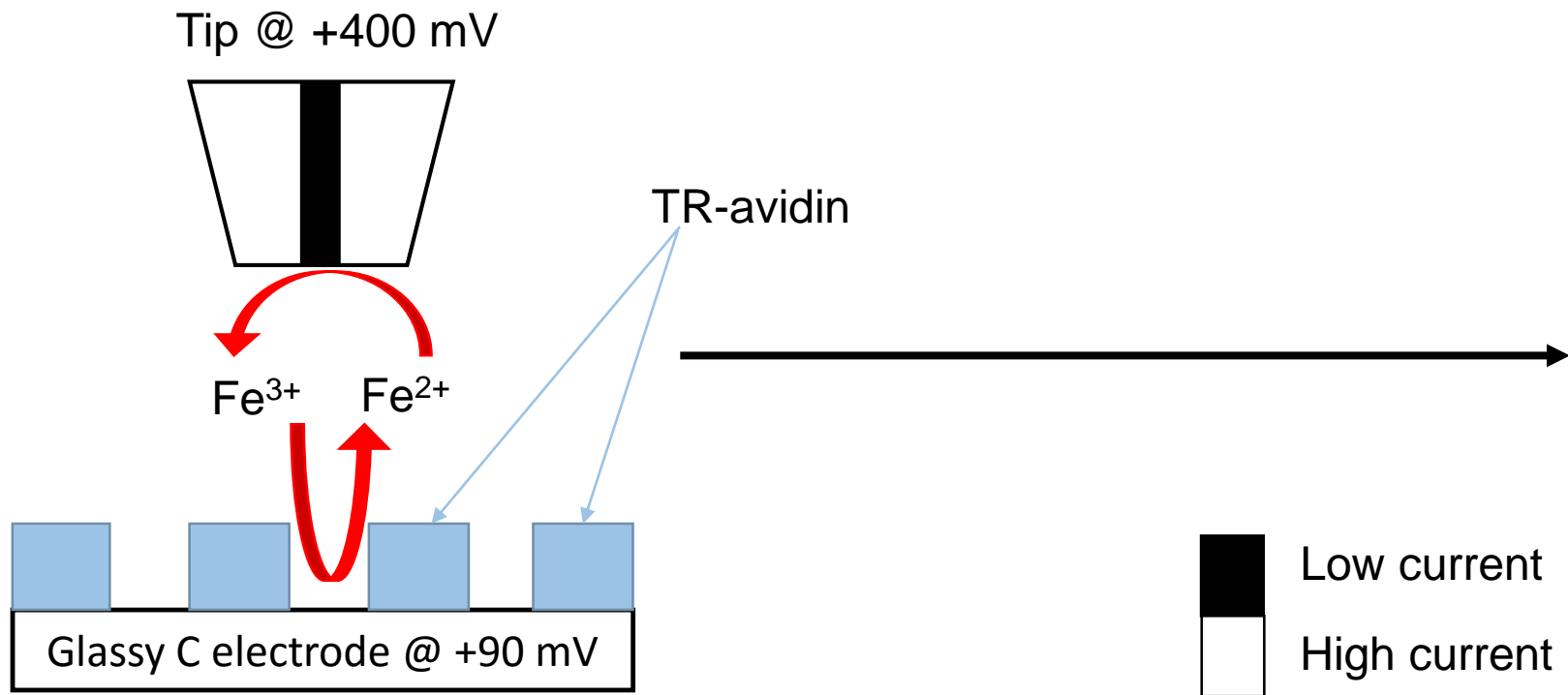

Microchannels were created to allow a diffusion of the mediator between active site of immobilized enzyme (on TR-avidin) and the surface of the carbon electrode.

SECM is used to probe electron transfer kinetics on the modified surface.

G/C mode for composition optimization

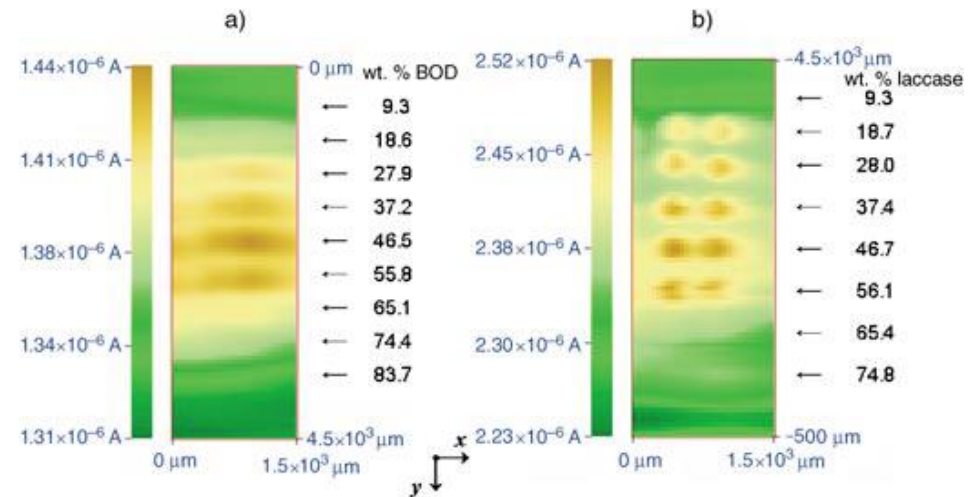
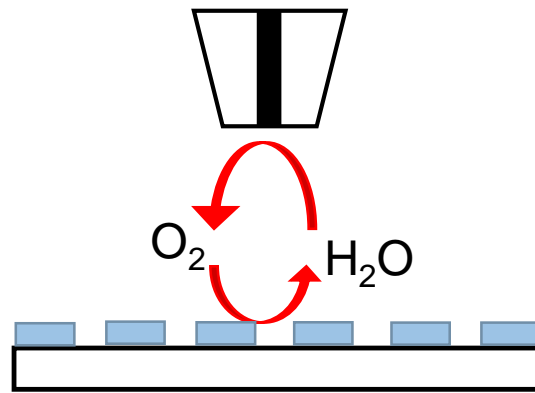
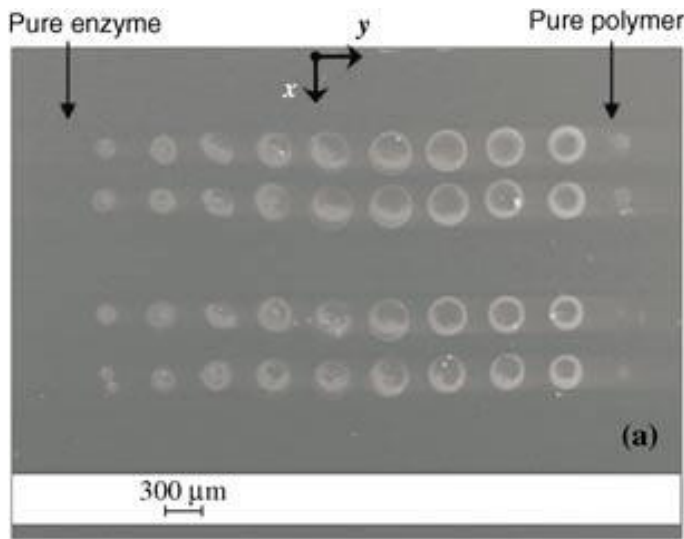

Sample O_2 electroreduction current for BOD and laccase enzyme with respective percentage.

SEM photograph of two arrays of redox-polymer–laccase spots made with 6.5 wt.% cross-linker. Each two-dot row corresponds to a particular composition.

O_2 produced at the tip is collected at the sample.

SECM is used to optimize the composition ratio of polymer/enzyme. In this case the application is Bio-fuelcell.

Feedback mode to image enzyme reactivity

Negative Feedback

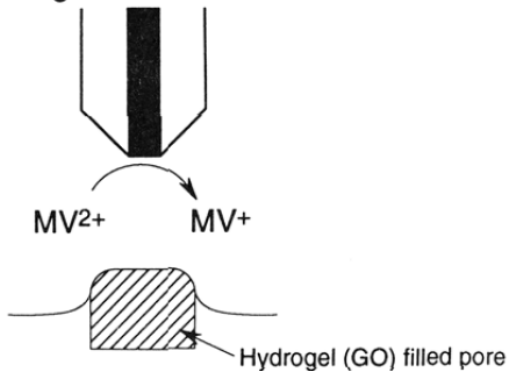

Positive Feedback

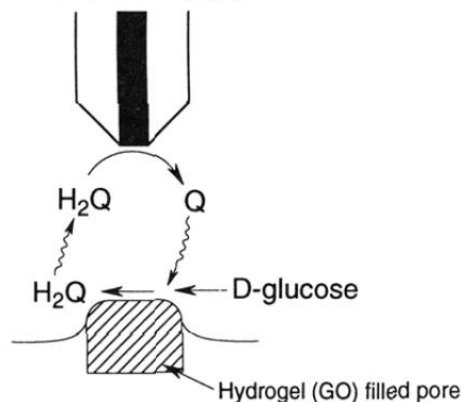

C

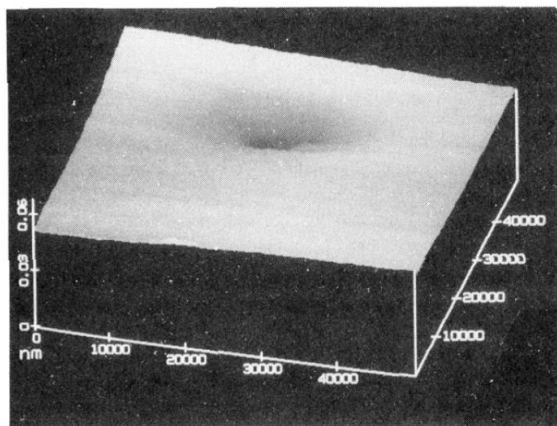
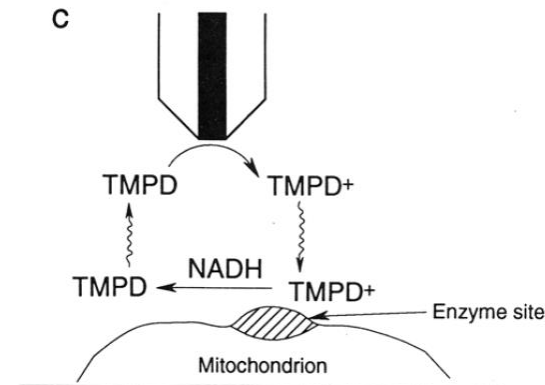

Negative feedback image of a glucose oxidase enzyme trapped in a pore. MV^{2+} = methylviologen

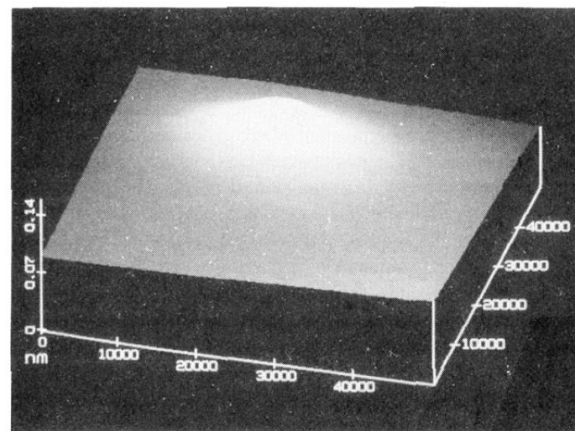

Positive feedback image of a glucose oxidase enzyme trapped in a pore. Q: quinone; H_2Q : hydroquinone

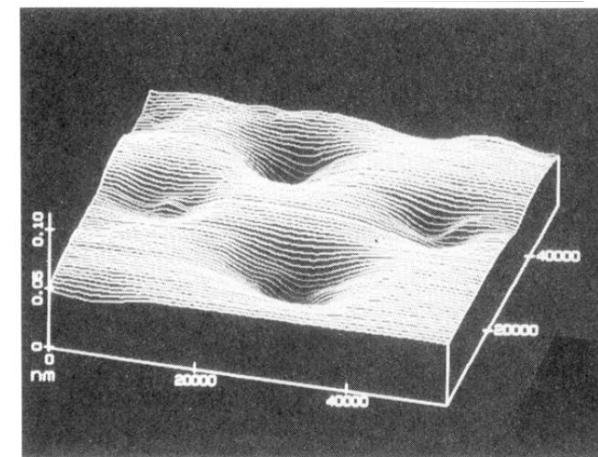

Positive feedback image of a glucose oxidase enzymes immobilized on a mitochondrion

Feedback mode to optimize chemistry

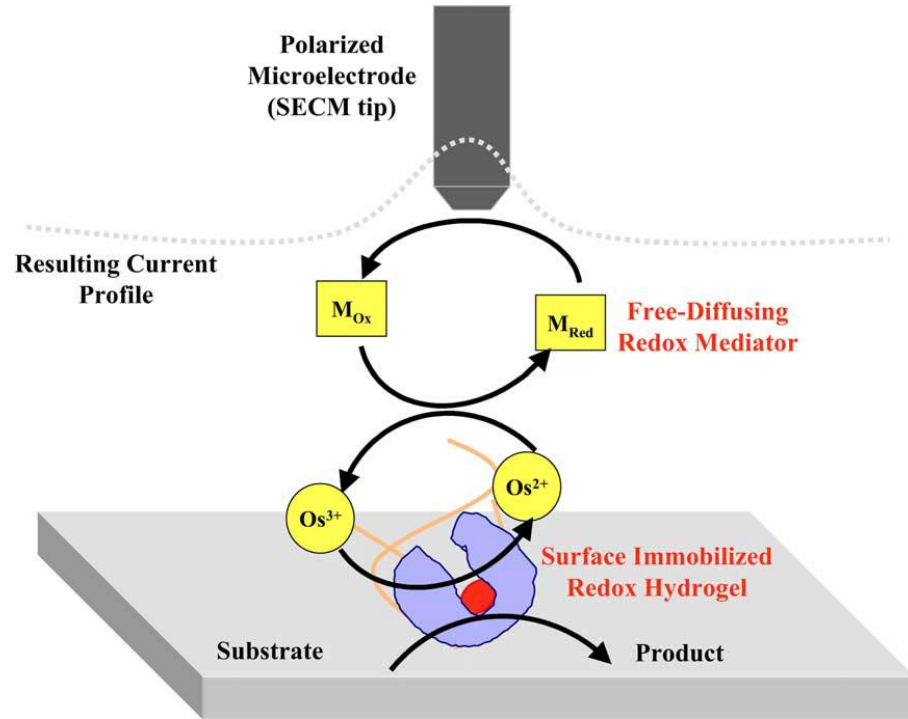

Strategy used: the target surface is covered with a thin film of polymer containing a redox relay (Os^{3+}) and the enzyme. Enzyme substrate is in solution as well as a mediator to regenerate the relay.

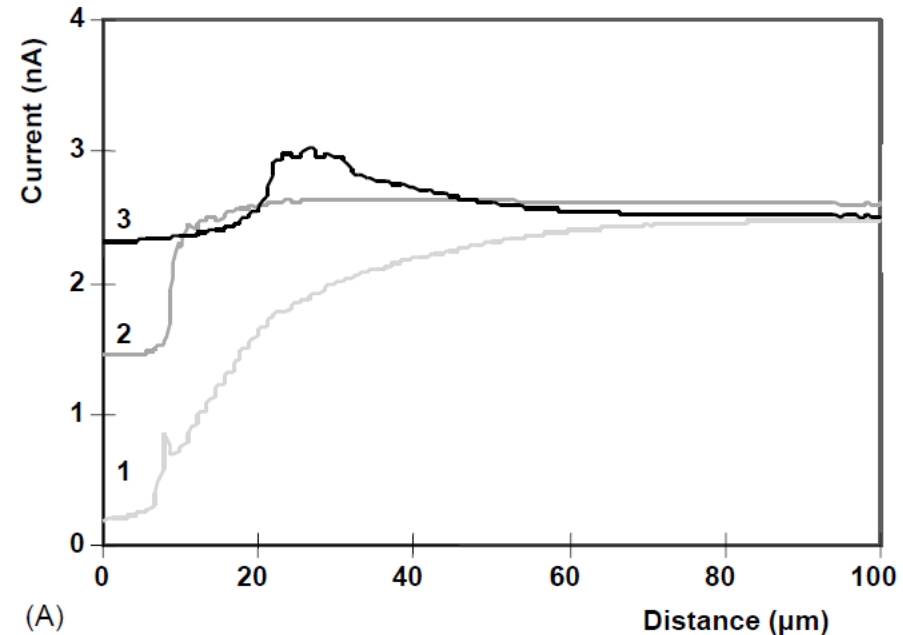

- Approach curves performed on a glass surface
- 1) BSA, PVI without Os and PEGDGE (cross linker)
 - 2) QH-ADH (enzyme), PVI without Os and PEGDGE
 - 3) QH-ADH, PVI13dmeOs and PEGDGE

The surface moves from an insulator behavior towards an almost conductor behavior due to the effect of the enzyme, and the positive effect of the presence of the redox relay in the hydrogel.

Feedback mode for DNA characterization

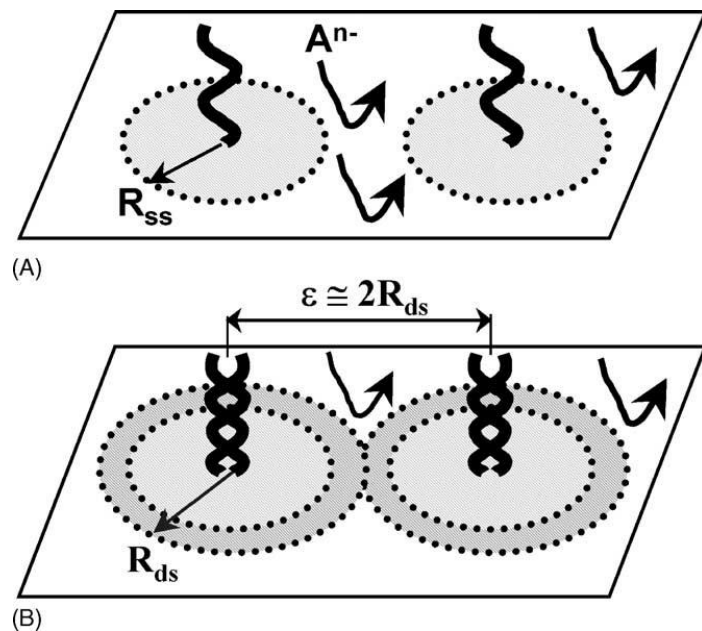

DNA blocks the diffusion of anions to the conducting surface due to the phosphate groups on the DNA strand. Double stranded DNA will block the anions more than single stranded DNA.

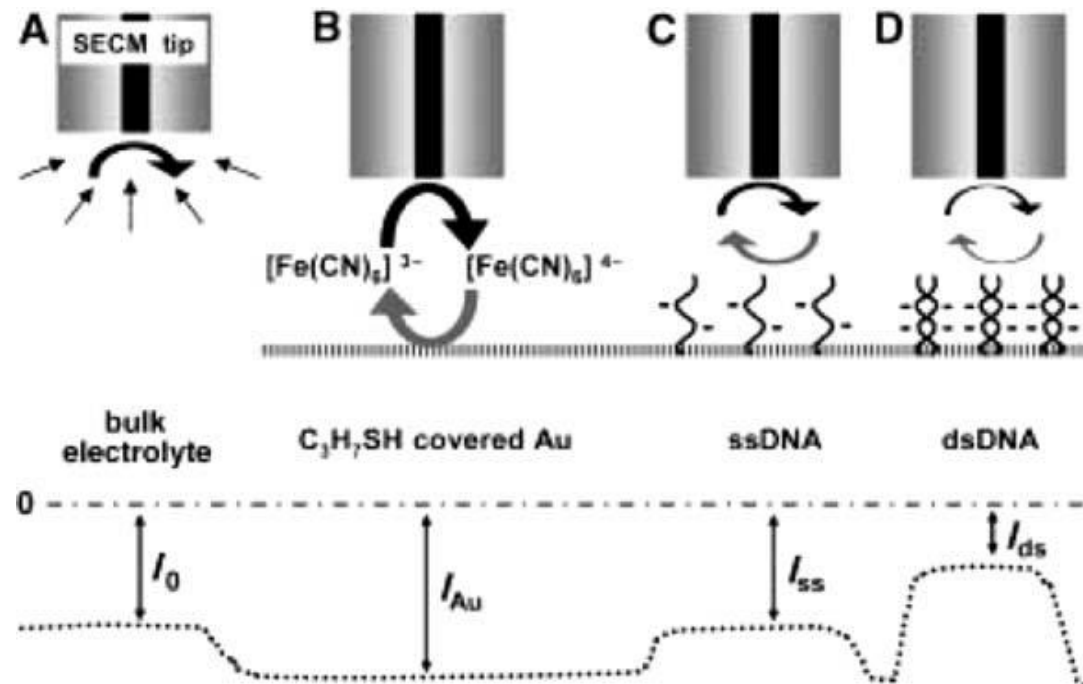

Positive feedback is hindered by the presence of DNA. The reduction of current is larger for dsDNA than for ssDNA.

SECM can be used to detect and discriminate single stranded and double stranded DNA.

Direct mode for local (de)activation of enzymes

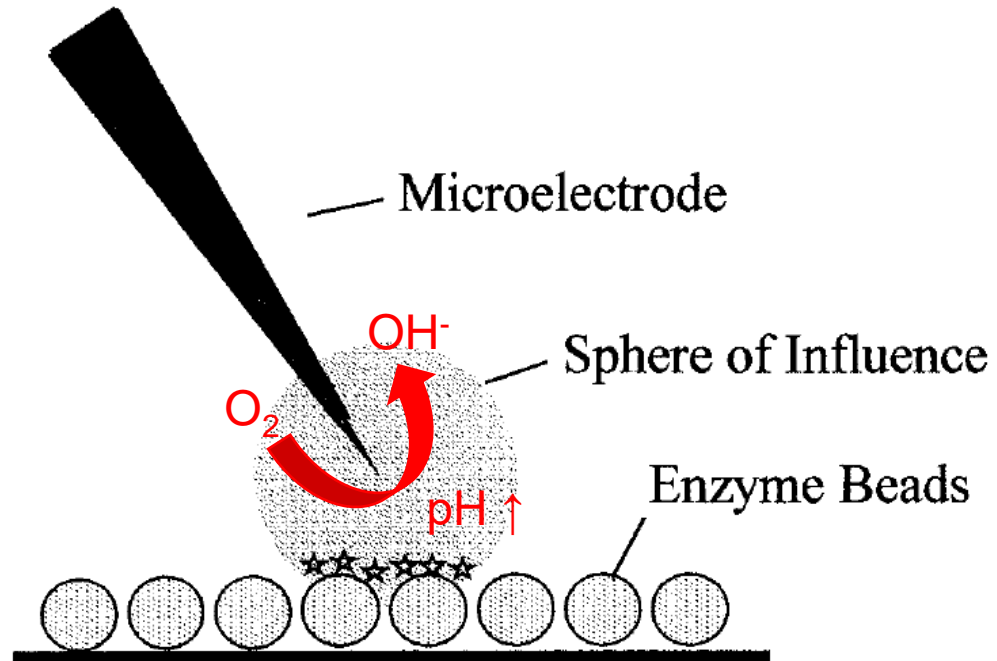

A solution at pH 6 is used. The microelectrode is reducing O_2 into OH^- to locally produce a pH 9, at which the enzyme is activated.

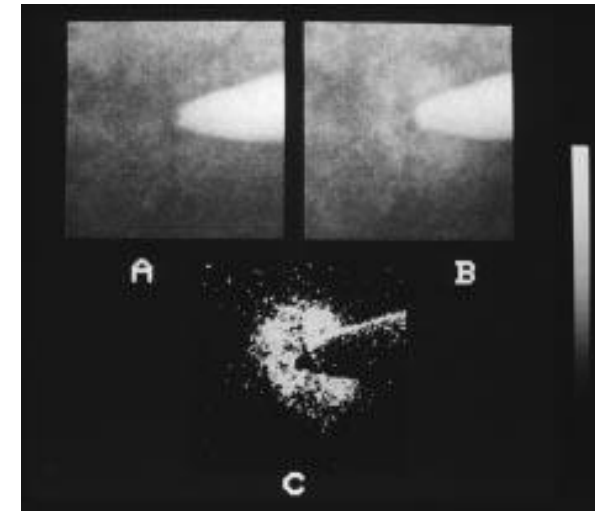

The activity of the enzyme is detected by fluorescence.

SECM can be used to locally change the environment of a receptor and study its response.

Direct mode for local polymer deposition

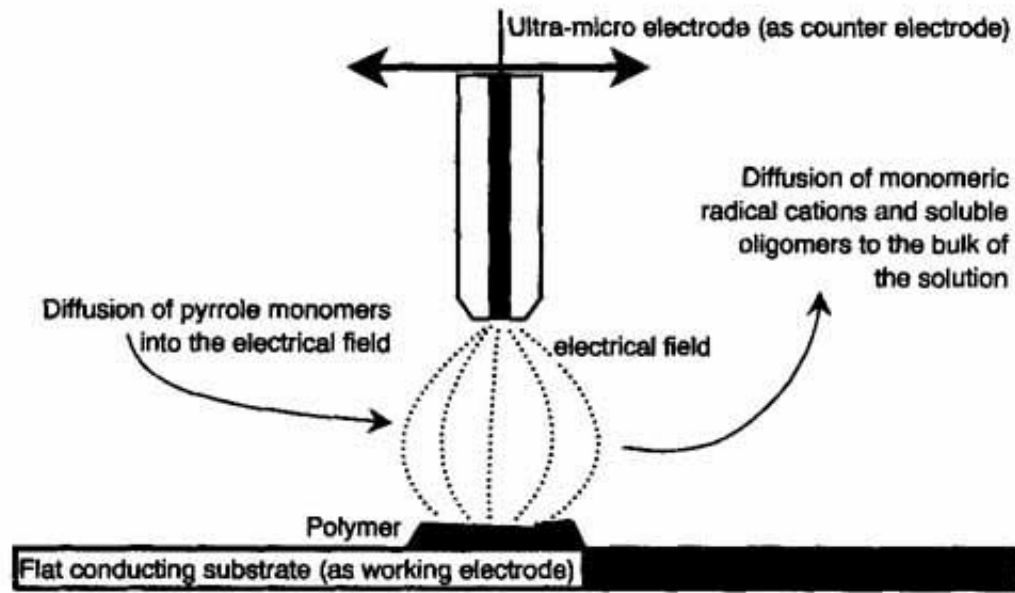

SECM was used in direct mode to deposit lines of polypyrrole on the surface of a gold substrate. A pulse deposition protocol is established.

Note that monitoring of thickness and amount of deposited material could be done with a Quartz Crystal Microbalance.

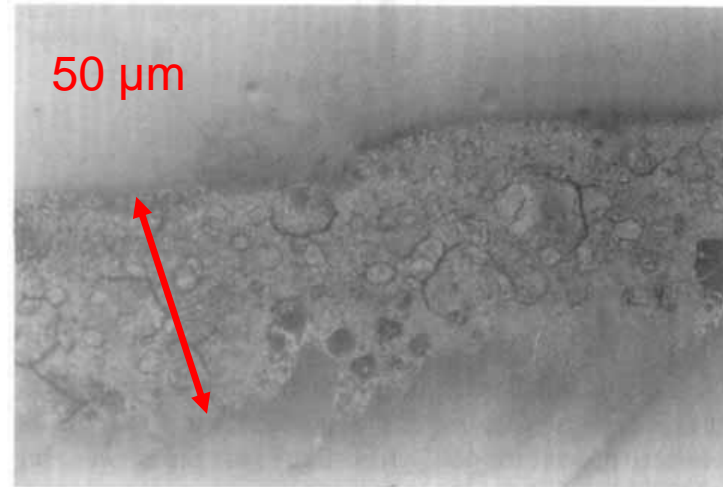
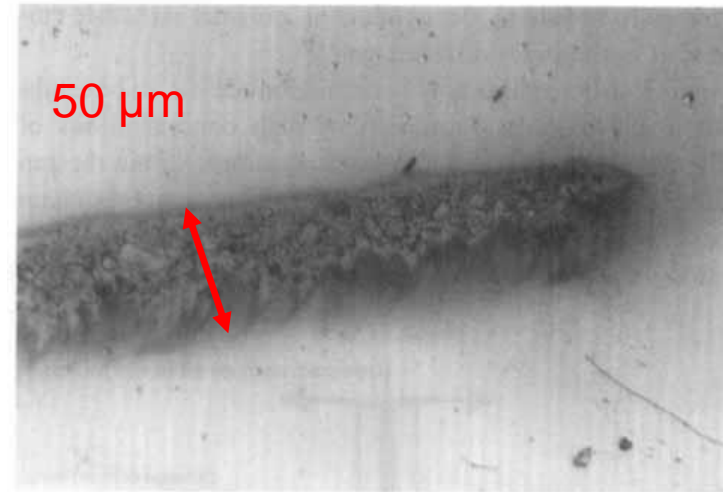

Direct mode for local functionalization

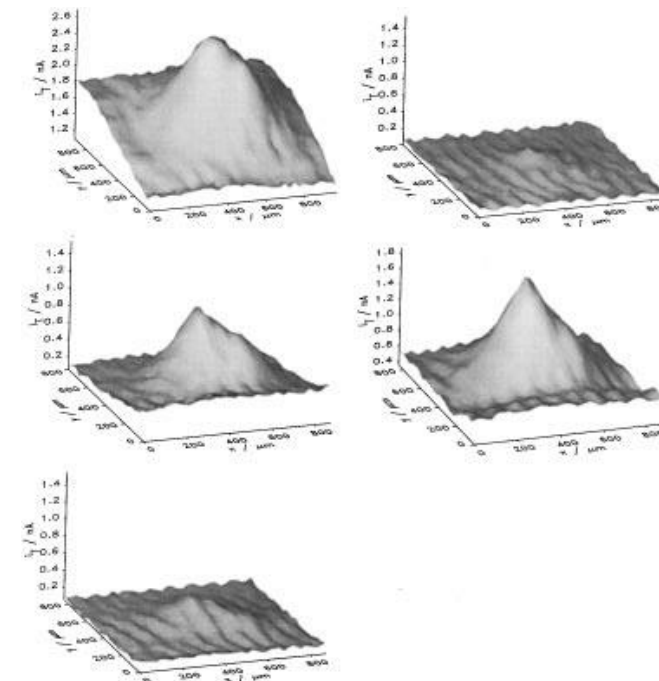
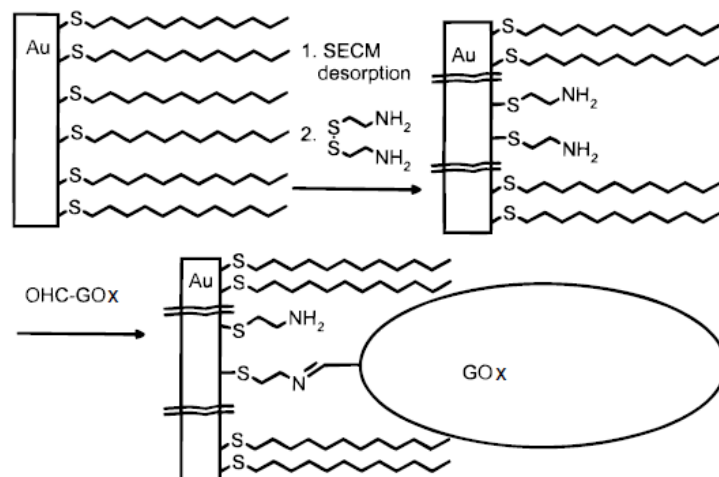
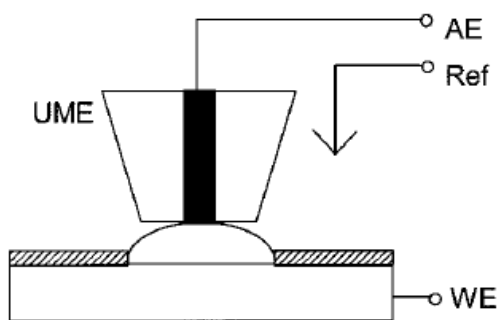

1. SECM desorption of chemisorbed alkanethiolate monolayer performed in 5 or 50 mM KOH. Two cyclic voltammograms (CVs) between -1200 and +1200 mV were performed, starting and finishing at 0 mV.
2. Cystaminium dihydrochloride (Merck) was chemisorbed onto the renewed gold surface from a 100 mM solution in water during 30 min.
3. A suspension of periodate-oxidized glucose oxidase (GOx) is added.

Enzyme activity is then showed using SECM in generation /collection mode using O_2/H_2O_2 couple as mediator.

SECM can be used to locally modify the surface and investigate new immobilization methods.